



www.polyskid.com
P. O. Drawer 349, Monticello, GA. 31064
Phone: 800-542-7659
Fax: 706-468-2881
E-Mail: polytech@polyskid.com

HOW TO INSTALL YOUR POLY LAST™ DEERE Corn Head Auger Trough Covers

DEERE ONLY!

443, 493, 444, 494, 643, 693, 693SH, 644, 694, 843, 893, 844, 894, 1293

PLEASE READ ENTIRE INSTRUCTION SHEET BEFORE STARTING INSTALLATION

First, compare the contents with the enclosed "Packing Slip" to confirm that you have received the correct panels and associated hardware for your model header.

NOTE:

THE TERMS "LEFT" AND "RIGHT" and "FRONT" AND "REAR" ARE DETERMINED BY FACING IN THE DIRECTION THE COMBINE WILL TRAVEL WHEN IN USE.

3 PANEL KIT

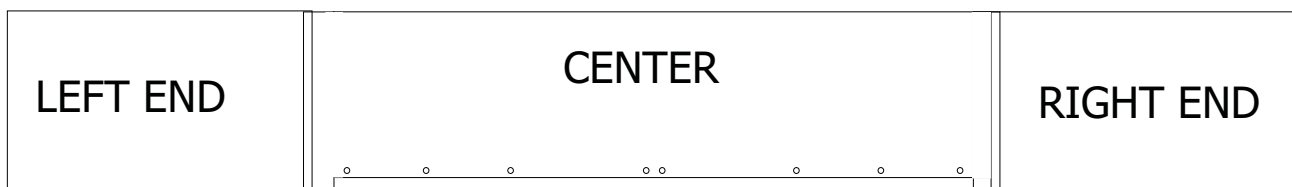

5 PANEL KIT



PLEASE REFER TO THE OPERATORS MANUAL FOR YOUR SPECIFIC COMBINE AND HEADER FOR PERTINENT SAFETY PRECAUTIONS PRIOR TO BEGINNING INSTALLATION.

1. With the header detached from the combine, remove the factory bolts along the rear edge of the feeder house opening.

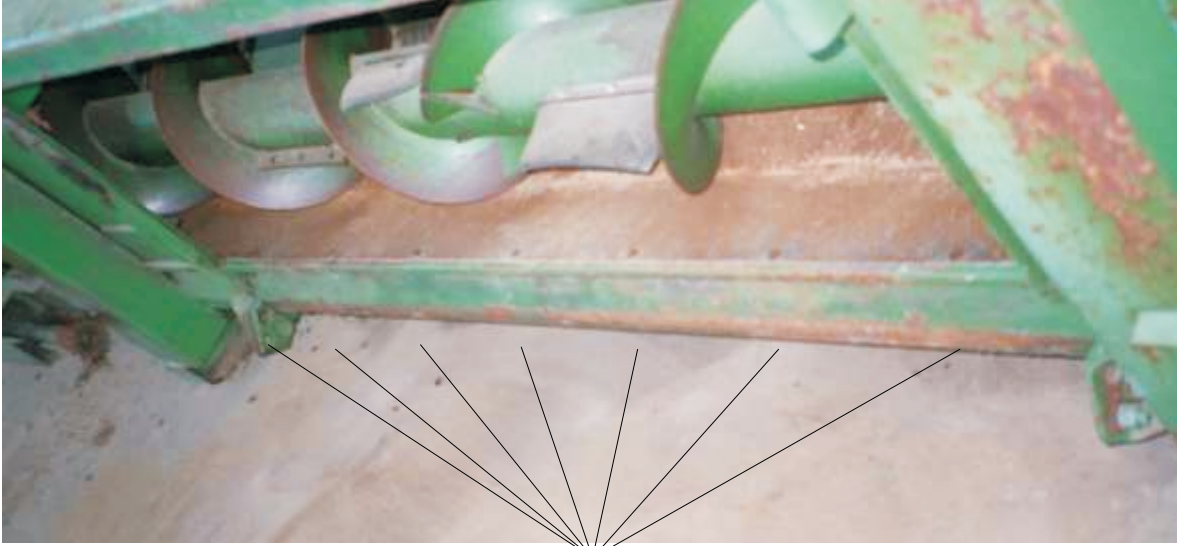

REMOVE

NOTE: THESE BOLTS WILL BE REPLACED WITH NEW CARRIAGE BOLTS INCLUDED IN THE KIT.



2. Clean the entire length of the auger trough to remove all dirt and crop residue.
3. Remove all patches, repairs or added bolts that would restrict the poly covers from laying flat against the top surface of the metal trough.

NOTE:

The poly covers can be installed over heavily worn metal and over holes in the metal plates if the holes do not exceed 4 inches in width (front to back) and are less than 24 inches in length (left to right)

4. From the front side of the header, insert the CENTER poly panel under the auger as illustrated below.

Using a mallet or hammer and wooden block, drive the panel rearward into position. Keep the panel centered on the feeder house opening by making slight adjustments from left to right as necessary.





5. With the Poly panel pushed fully to the rear and the rear mounting holes aligned, pry the front edge of the panel behind and under the steel plate at each row with a large screw driver or pry bar.

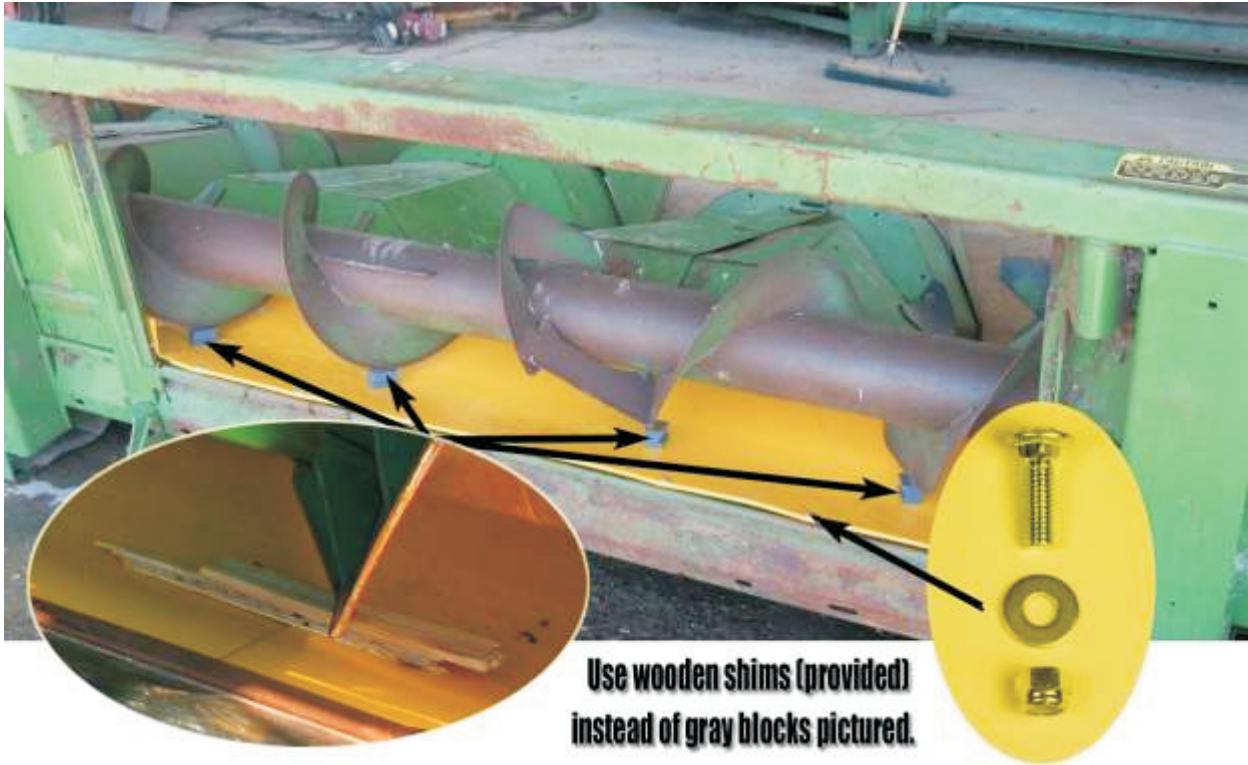

NOTE: IT IS VERY IMPORTANT THAT THE LEADING EDGE OF THE POLY PANEL "SNAPS" INTO PLACE BEHIND AND UNDER THE STEEL PLATE AT EACH ROW.

6. Press the Poly panel against the metal by inserting the wooden shims blocks at each auger flight as illustrated below.



 IMPORTANT:	Tighten the nut to seat the head of the bolt then loosen the nut 3/4 turn.
This will allow the liner to expand and contract with temperature change.	

7. Check the alignment of the mounting holes. Adjust panel if necessary.

8. Secure the rear edge of the Poly panel with the carriage bolts supplied.



Use the silicone sealant supplied to seal around each bolt head and to fill in any unused holes.

9. With the wooden shims still in place, attach the header to the combine.

Raise the feeder house, lifting the corn head all the way up. Shut off engine, remove key, and set parking brake.

LOWER SAFETY STOP ONTO HYDRAULIC CYLINDER. (A)

PLEASE REFER TO THE OPERATORS MANUALS FOR YOUR SPECIFIC COMBINE AND CORN HEAD FOR PROPER PROCEDURES AND PERTINENT SAFETY PRECAUTIONS FOR SECURING CORN HEAD TO THE COMBINE.

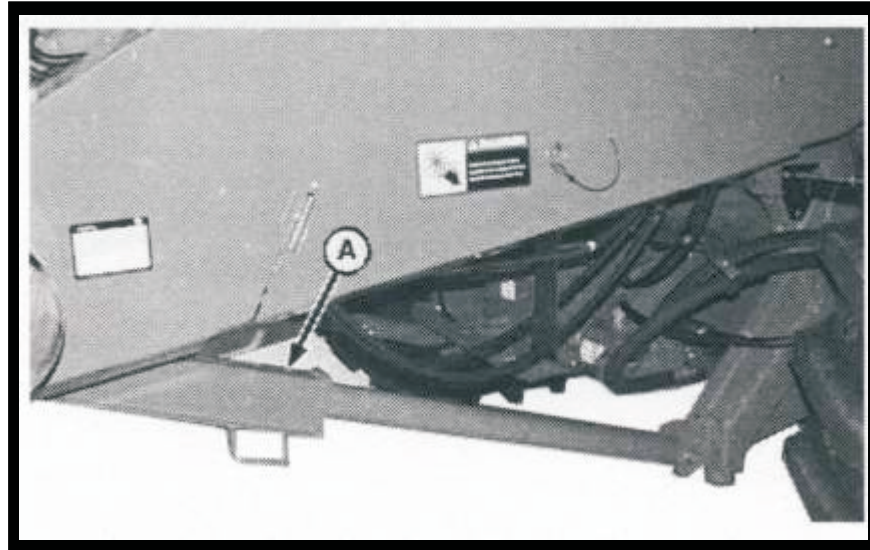

10. With the corn head raised and secured, measure the underside of the head from left to right and mark the mid-point as illustrated below:

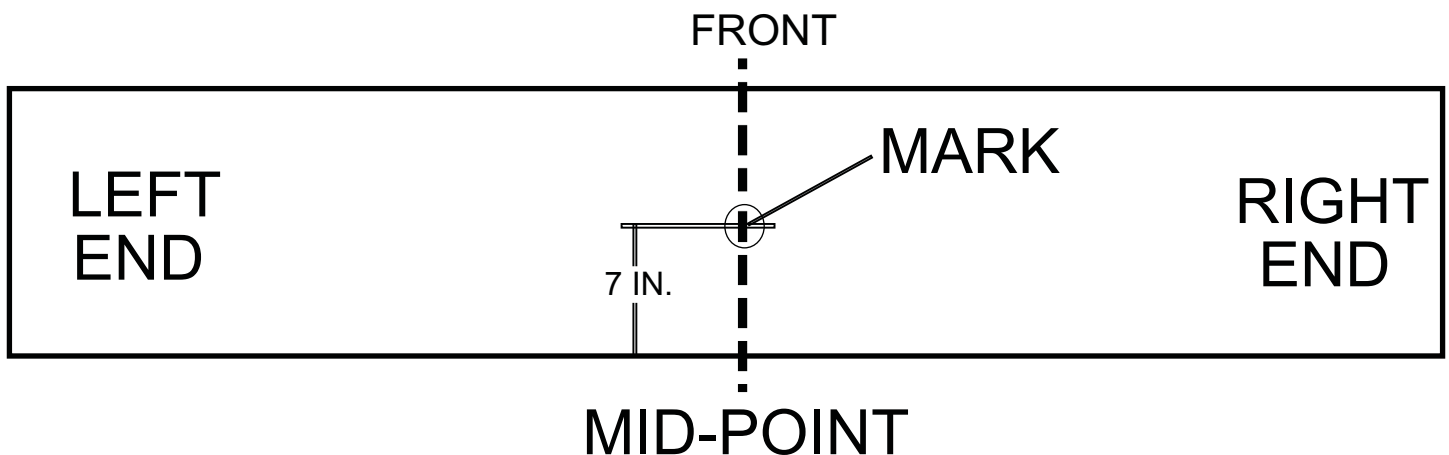



USE SAFETY GLASSES:

Wear safety glasses or goggles while operating power tools. Basic safety precautions should always be followed to reduce risk of personal injury.

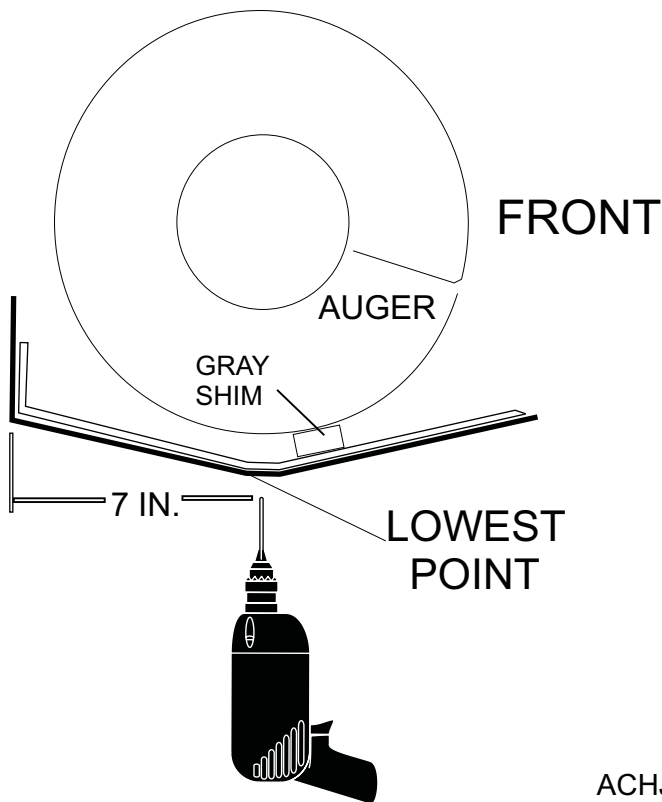
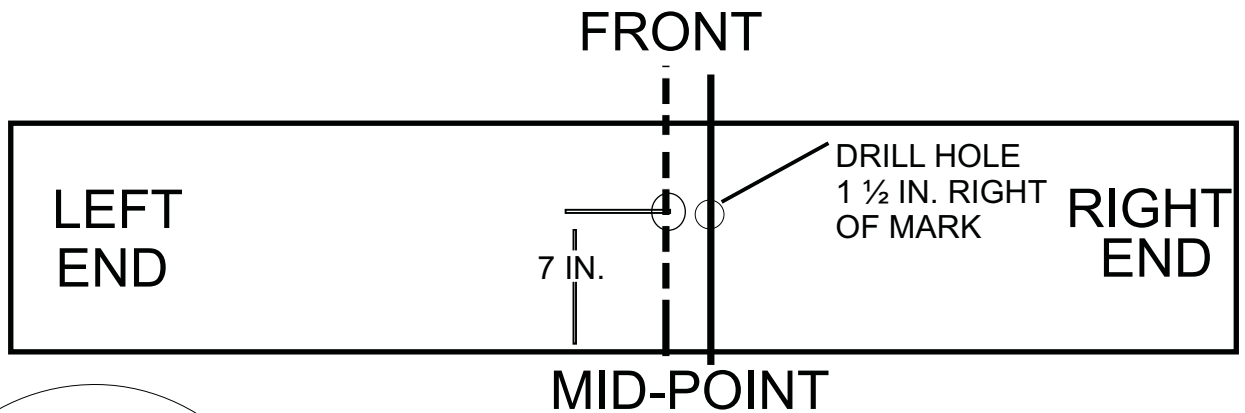

11. Drilling upward from underneath the header, use the 3/8 drill bit supplied to drill thru the metal trough and Poly cover 1 1/2 inches to the right of the MID-Point.



12. Install and tighten a 1/4-20 x 1 1/4 fanged bolt in the center hole.

	<p>IMPORTANT: Tighten the nut to seat the head of the bolt then loosen the nut 3/4 turn.</p>
<p>This will allow the liner to expand and contract with temperature change.</p>	

13. Using the center bolt as a reference, mark and drill the outer two holes in the center panel from underneath the header as in step (11) Install and tighten a fanged bolt in each hole.

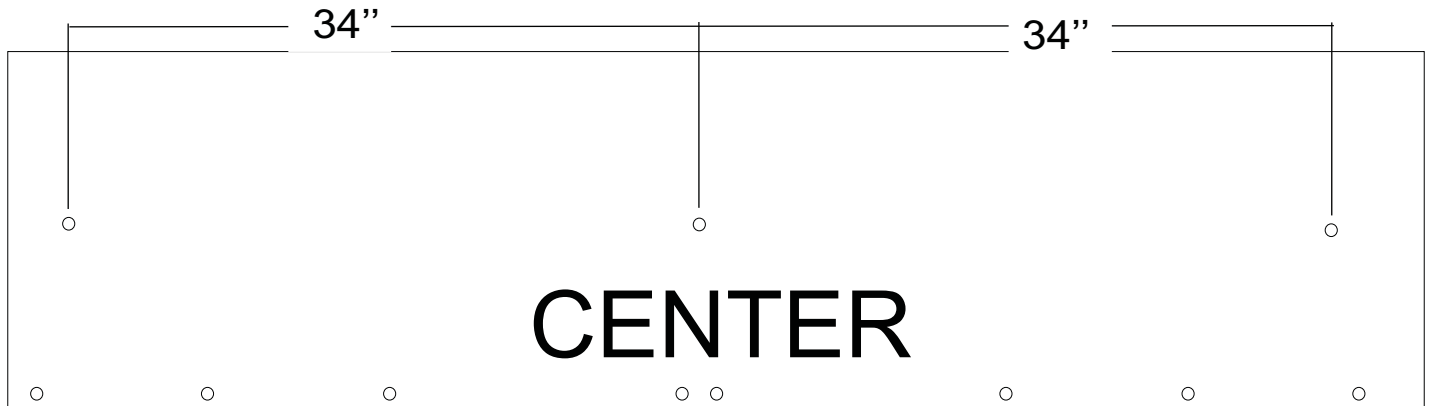

14. Next, insert the Left and Right panels on a 3 PANEL KIT OR the Left and Right Center panels on a 5 PANEL KIT.

Drive the panels to the rear of the auger trough as in Step 4 , but

DO NOT PRY THE LEADING EDGE BEHIND THE STEEL PLATE AT THIS TIME.



15. Using the black 3/16" gauge, position the panels so there is a 3/16" gap at each joint as illustrated below.

For a 5 PANEL KIT, now insert the end panels and position with the 3/16" gauge.

16. With all the panels positioned with a 3/16" gap at each joint, pry the leading edge of each panel behind and under the steel plate as in Step 5.



17. To complete the installation, (working from the center outward), layout and drill each panel from underneath the header using the Recommended Hole Location guide below.

Transfer the wood shims to each panel before drilling.

Install and tighten a fanged bolt in each hole before drilling the next hole.

 IMPORTANT:	Tighten the nut to seat the head of the bolt then loosen the nut 3/4 turn.
This will allow the liner to expand and contract with temperature change.	

RECOMMENDED HOLE LOCATION

Model #'s 444,494,643,644,693,693SH,694

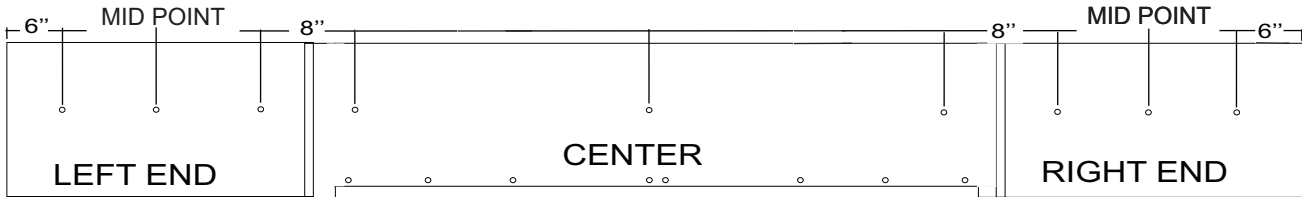

Model #'s 1293,844,894,843,893

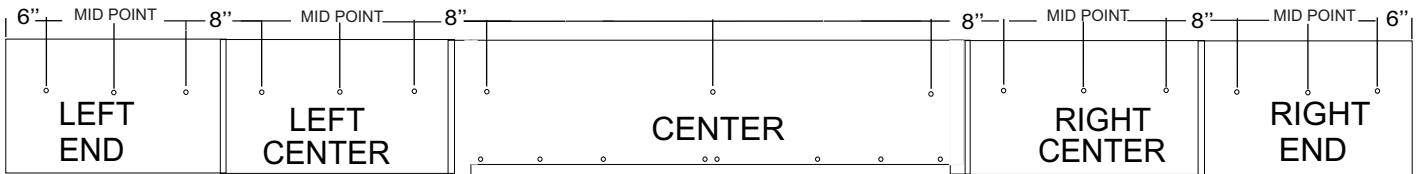

NOTE:

Model #'s 443, 493 get only two fanged bolts per end panel.

Hole locations may be moved to avoid areas where the metal trough is too thin or worn through.

18. Readjust the auger height for desired clearance. The fore-and-aft clearance should not be effected.

QUESTIONS OR COMMENTS

1.800.542.7659

polytech@polyskid.com